

**terra** 

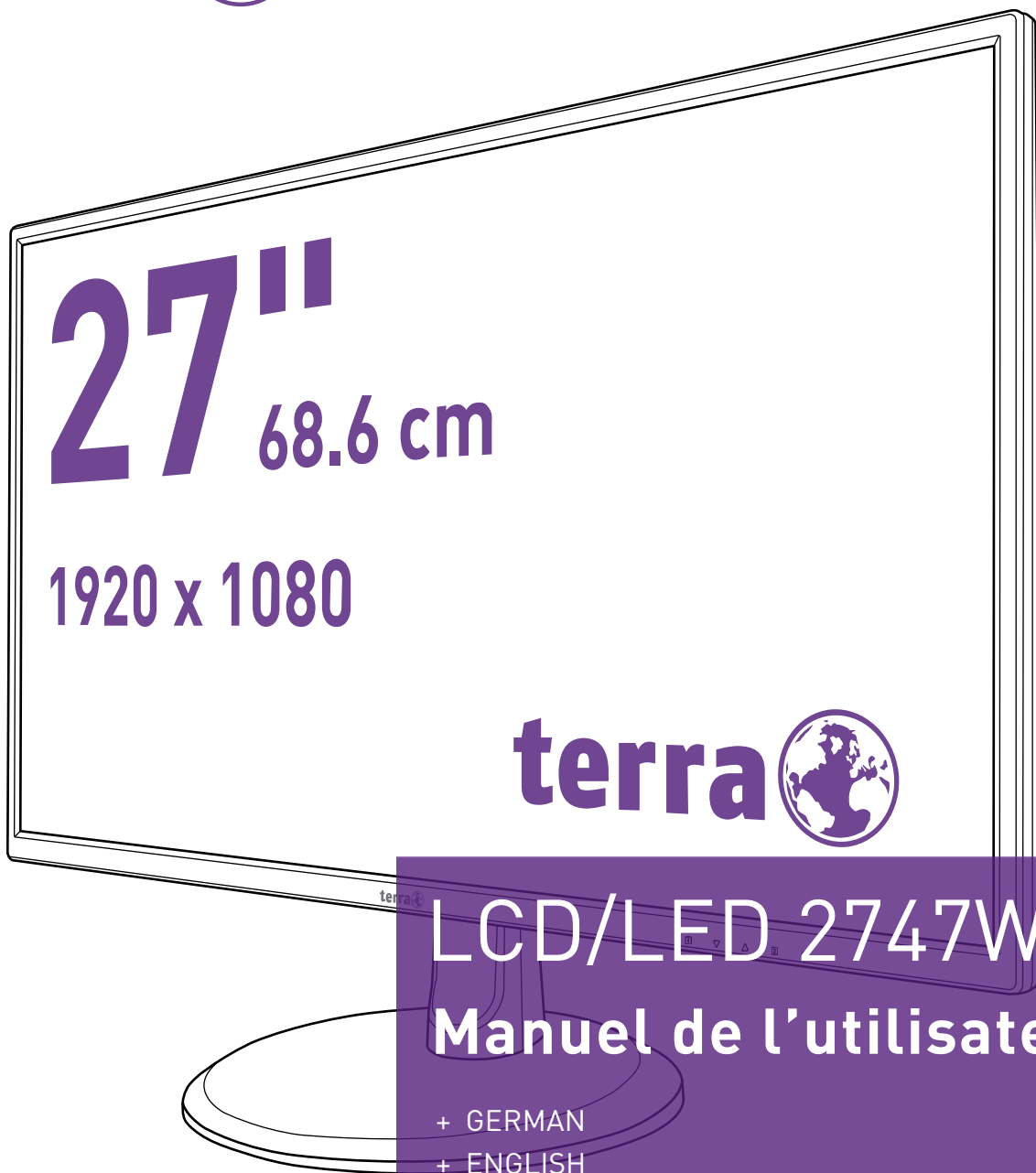

**LCD/LED 2747W**

**Manuel de l'utilisateur**

- + GERMAN
- + ENGLISH
- + FRENCH
- + SPANISH
- + ITALIAN
- + RUSSIAN

**WORTMANN AG**

---

Précautions de sécurité et entretien	1
Configuration de base	2
Configuration de l'image à l'écran	2
<b>Fonctions</b>	<b>3</b>
LUMINOSITÉ	3
IMAGE	3
TEMP. COULEUR	4
Réglages OSD	5
RESET	6
AUTRES	7
Installation du moniteur à DEL	8
Modes de fréquence pris en charge	9
Dépannage	10
SPÉCIFICATIONS	11

---

## Précautions de sécurité et entretien

Lisez attentivement ce manuel et conservez-le pour référence future

1. Débranchez l'écran avant de le nettoyer un chiffon légèrement humide.
2. Il est conseillé d'essuyer l'écran avec un chiffon sec, et uniquement après avoir éteint l'appareil.
3. N'utilisez pas de produits à base d'ammoniaque ou d'alcool.
4. Ce moniteur est conçu avec des trous de ventilation sur l'arrière du boîtier. Ne les couvrez et ne les bloquez pas.
5. Évitez également de placer le moniteur près d'un radiateur électrique ou autre. Évitez aussi les pièces fermées sans ventilation.
6. N'insérez pas d'objets à l'intérieur et ne versez pas de liquide dessus.
7. Ne placez pas le moniteur sur une surface instable. S'il tombe, il pourrait s'abîmer et blesser l'utilisateur.
8. Débranchez le moniteur si vous envisagez de ne pas l'utiliser pendant un certain temps.
9. Ne placez pas d'objets lourds sur le moniteur ou sur son cordon électrique.
10. N'ouvrez pas le panneau arrière du moniteur, car des tensions élevées se trouvent à l'intérieur.

### Table des matières

- \* Moniteur
- \* Câble HDMI
- \* Cordon d'alimentation (C5)
- \* Carte de garantie
- \* Guide Rapide
- \* Câble audio

### Caractéristiques :

- \* Couleurs d'image haute qualité 16.7M
- \* Menu OSD de réglage intelligent de l'image avec une organisation simple et une sélection facile
- \* Interfaces de contrôle intelligentes pour des réglages faciles



Base de données de l'UE sur les produits pour l'étiquetage énergétique et la fiche d'information sur les produits.

2747W : <https://eprel.ec.europa.eu/qr/380527>

## Configuration de base

a) Connectez un câble DVI ou Câble HDMI pour PC (sortie de signal) et sur le moniteur.

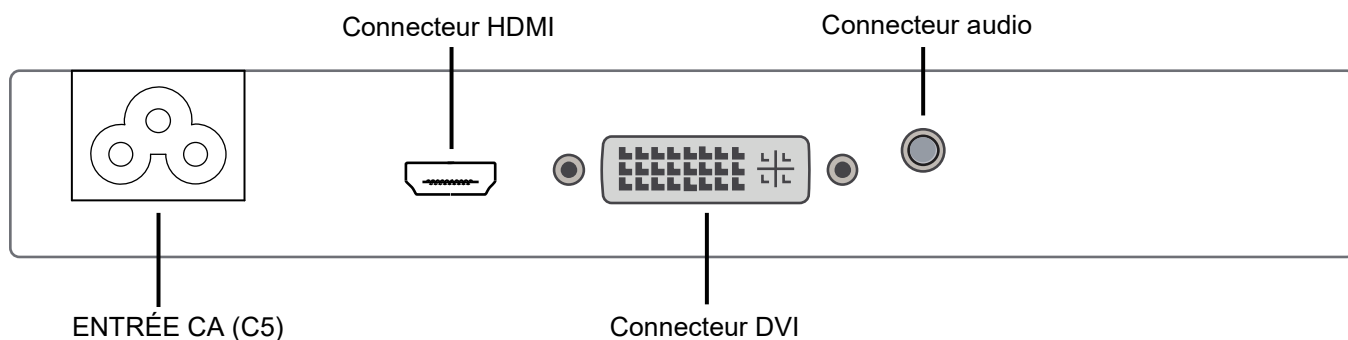

b) Le moniteur dispose d'une plage de tensions large; vous pouvez l'utiliser sur une alimentation 100-240 V CA ~ 60/50 Hz.

c) Connectez le câble d'alimentation à la prise d'alimentation du moniteur et à la source d'alimentation de la pièce.

d) Allumez la source d'alimentation.

e) Pour allumer l'écran, appuyez sur la touche de commande de l'alimentation.

## Configuration de l'image à l'écran

Le derrière droit de l'écran comprend cinq touches pour ajuster les réglages du moniteur à l'aide du menu à l'écran.



②	Confirmer la sélection dans le menu / Sélection de source lorsqu'aucune option de menu n'est sélectionnée
△	Ajuster les options - déplacer vers le haut / Régler la Anti Blue Light lorsqu'aucune option de menu n'est sélectionnée
▽	Ajuster les options - déplacer vers le haut ou le bas / Régler la luminosité lorsqu'aucune option de menu n'est sélectionnée
	Affiche le menu principal ou quitte le menu
①	Appuyez longuement sur la touche [ ① ] pour verrouiller le menu OSD. Puis appuyez longuement sur la touche [ ① ] pour déverrouiller le menu OSD.
	Mise sous/hors tension
⏻	Appuyez longuement sur la touche [ ⏻ ] pour verrouiller l'alimentation. Puis appuyez longuement sur la touche [ ⏻ ] pour déverrouiller l'alimentation.

**Remarque: La modification des paramètres OSD peut augmenter la consommation électrique.**

## Fonctions:

### LUMINOSITÉ

Appuyez sur la touche [1], le menu principal s'affichera comme suit:

Appuyez sur la touche  $\Delta$  /  $\nabla$  pour sélectionner **LUMINOSITÉ** dans le menu principal, puis appuyez sur la touche [2] pour accéder.

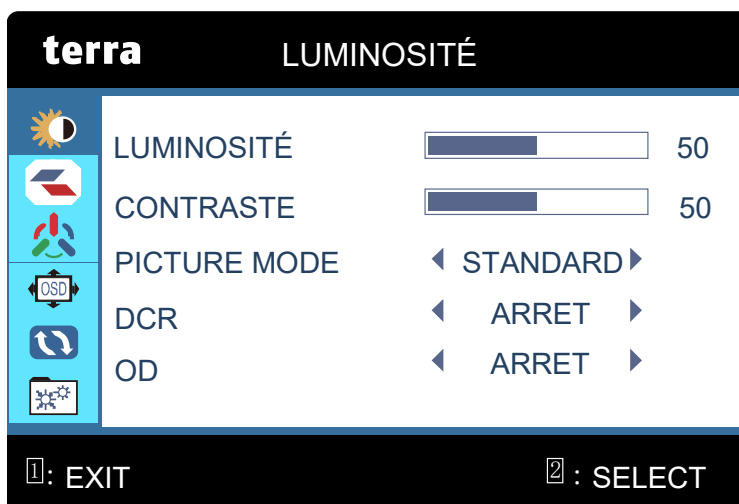

#### LUMINOSITÉ

Appuyez sur la touche  $\Delta$  /  $\nabla$  pour sélectionner **LUMINOSITÉ**, puis appuyez sur la touche [2] pour confirmer le choix et appuyez sur la touche  $\Delta$  /  $\nabla$  pour régler.

#### CONTRASTE

Appuyez sur la touche  $\Delta$  /  $\nabla$  pour sélectionner **CONTRASTE**, puis appuyez sur la touche [2] pour confirmer le choix et appuyez sur la touche  $\Delta$  /  $\nabla$  pour régler.

#### PICTURE MODE

Appuyez sur la touche  $\Delta$  /  $\nabla$  pour sélectionner **PICTURE MODE**, puis appuyez sur la touche [2] pour confirmer le choix et appuyez sur la touche  $\Delta$  /  $\nabla$  pour choisir STANDARD, FILM, JEU, TEXTE.

#### DCR (Taux de contraste dynamique)

Appuyez sur la touche  $\Delta$  /  $\nabla$  pour sélectionner **DCR**, puis appuyez sur la touche [2] pour confirmer le choix et appuyez sur la touche  $\Delta$  /  $\nabla$  pour choisir ARRET ou MARCHE.

#### OD (Overdrive)

Appuyez sur la touche  $\Delta$  /  $\nabla$  pour sélectionner **OD**, puis appuyez sur la touche [2] pour confirmer le choix et appuyez sur la touche  $\Delta$  /  $\nabla$  pour choisir FORT, MILIEU, FAIBLE, ARRET.

### IMAGE

Appuyez sur la touche  $\Delta$  /  $\nabla$  pour sélectionner **IMAGE** dans le menu principal, puis appuyez sur la touche [2] pour accéder.



### ASPECT

Appuyez sur la touche  $\Delta$  /  $\nabla$  pour sélectionner **ASPECT**, puis appuyez sur la touche  $\text{[2]}$  pour confirmer le choix et appuyez sur la touche  $\Delta$  /  $\nabla$  pour choisir LARGE ou 4:3.

## TEMP. COULEUR

Appuyez sur la touche  $\Delta$  /  $\nabla$  pour sélectionner **TEMP. COULEUR** dans le menu principal, puis appuyez sur la touche  $\text{[2]}$  pour accéder.

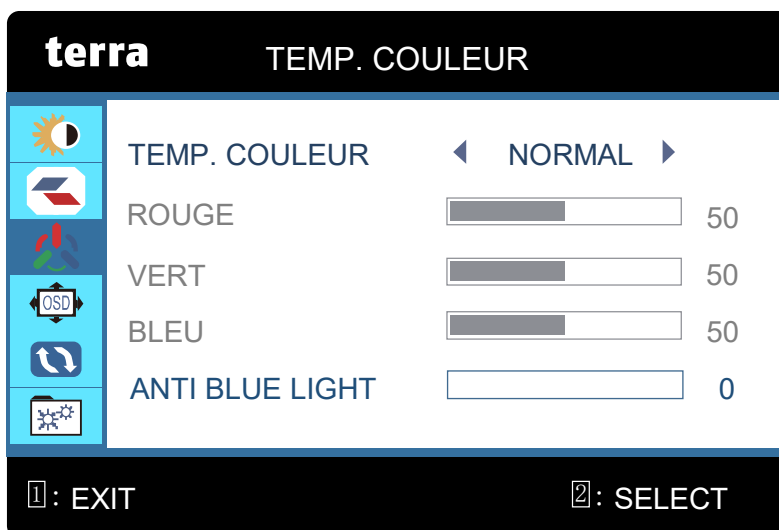

### TEMP. COULEUR

Appuyez sur la touche  $\Delta$  /  $\nabla$  pour sélectionner **TEMP. COULEUR**, puis appuyez sur la touche  $\text{[2]}$  pour confirmer le choix et appuyez sur la touche  $\Delta$  /  $\nabla$  pour choisir NORMAL, CHAUD, Personnalisé, FROID.

### ROUGE

Lorsque vous choisissez **TEMP. COULEUR Personnalisé**, appuyez sur les touches  $\Delta$  /  $\nabla$  pour sélectionner **ROUGE** puis appuyez sur la touche  $\text{[2]}$  pour ajuster la valeur des trois couleurs primaires du rouge.

**VERT**

Lorsque vous choisissez **TEMP. COULEUR Personnalisé**, appuyez sur les touches  $\Delta / \nabla$  pour sélectionner **VERT** puis appuyez sur la touche  $\text{[2]}$  pour ajuster la valeur des trois couleurs primaires du vert.

**BLEU**

Lorsque vous choisissez **TEMP. COULEUR Personnalisé**, appuyez sur les touches  $\Delta / \nabla$  pour sélectionner **BLEU** puis appuyez sur la touche  $\text{[2]}$  pour ajuster la valeur des trois couleurs primaires du bleu.

**ANTI BLUE LIGHT:** Diminue la lumière bleue émise par l'affichage pour réduire le risque d'exposition à la lumière bleue à vos yeux.

## Réglages OSD

Appuyez sur la touche  $\Delta / \nabla$  pour sélectionner **Réglages OSD** dans le menu principal, puis appuyez sur la touche  $\text{[2]}$  pour accéder.

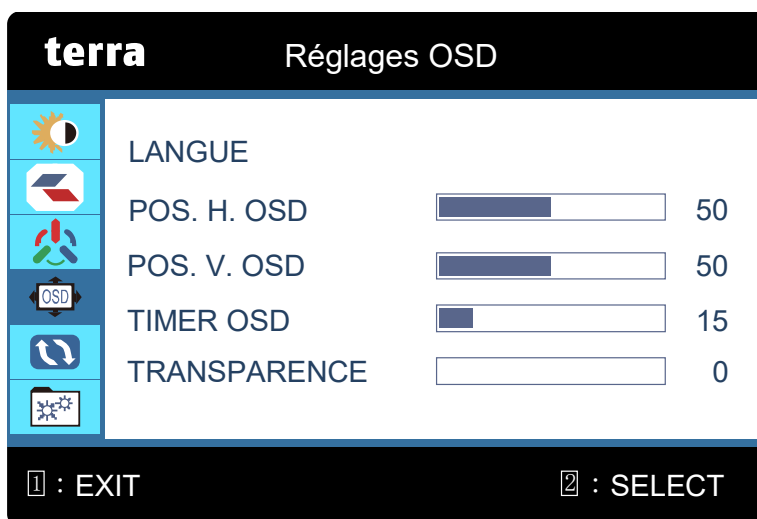
**LANGUE**

Appuyez sur la touche  $\Delta / \nabla$  pour sélectionner **LANGUE**, puis appuyez sur la touche  $\text{[2]}$  pour confirmer le choix et appuyez sur la touche  $\Delta / \nabla$  pour choisir, puis appuyez sur la touche  $\text{[2]}$  pour confirmer le choix (ENGLISH, FRANÇAIS, DEUTSCH, ITALIANO, ESPAÑOL, РУССКИЙ).



### POS. H. OSD

Appuyez sur la touche  $\triangle$  /  $\nabla$  pour sélectionner **POS. H. OSD**, puis appuyez sur la touche  $\text{[2]}$  pour confirmer le choix et appuyez sur la touche  $\triangle$  pour déplacer le menu OSD vers la droite. Appuyez sur la touche  $\nabla$  pour déplacer le menu OSD vers la gauche.

### POS. V. OSD

Appuyez sur la touche  $\triangle$  /  $\nabla$  pour sélectionner **POS. V. OSD**, puis appuyez sur la touche  $\text{[2]}$  pour confirmer le choix et appuyez sur la touche  $\triangle$  pour déplacer le menu OSD vers le haut. Appuyez sur la touche  $\nabla$  pour déplacer le menu OSD vers le bas.

### TIMER OSD

Appuyez sur la touche  $\triangle$  /  $\nabla$  pour sélectionner **TIMER OSD**, puis appuyez sur la touche  $\text{[2]}$  pour confirmer le choix et appuyez sur la touche  $\triangle$  /  $\nabla$  pour régler.

### TRANSPARENCE

Appuyez sur la touche  $\triangle$  /  $\nabla$  pour sélectionner **TRANSPARENCE**, puis appuyez sur la touche  $\text{[2]}$  pour confirmer le choix et appuyez sur la touche  $\triangle$  /  $\nabla$  pour régler.

## RESET

Appuyez sur la touche  $\triangle$  /  $\nabla$  pour sélectionner **RESET** dans le menu principal, puis appuyez sur la touche  $\text{[2]}$  pour accéder.

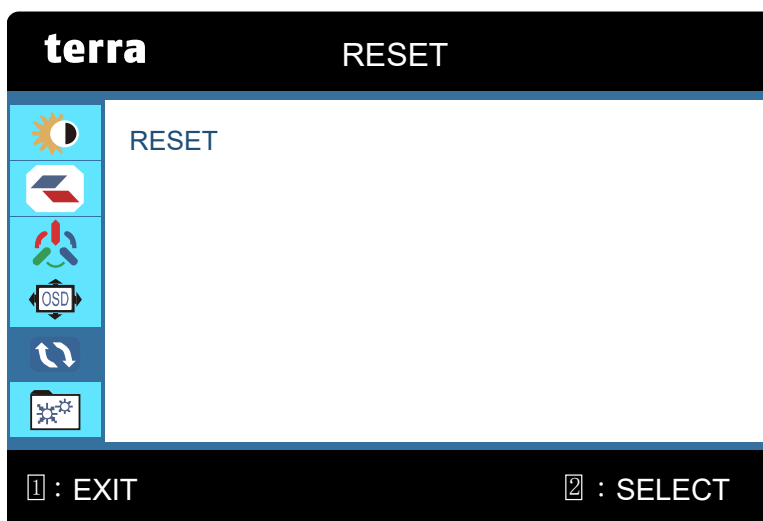

### RESET

Pour rétablir les paramètres d'usine pour les contrôles vidéo & audio.

## AUTRES

Appuyez sur la touche  $\triangle$  /  $\nabla$  pour sélectionner **AUTRES** dans le menu principal, puis appuyez sur la touche  $\text{[2]}$  pour accéder.



### ENTRÉE

Appuyez sur la touche  $\triangle$  /  $\nabla$  pour sélectionner **ENTRÉE**, puis appuyez sur la touche  $\text{[2]}$  pour confirmer le choix et appuyez sur la touche  $\triangle$  /  $\nabla$  pour choisir DVI ou HDMI, puis appuyez sur la touche  $\text{[2]}$  pour confirmer le choix.

### VOLUME

Appuyez sur la touche  $\triangle$  /  $\nabla$  pour sélectionner **VOLUME**, puis appuyez sur la touche  $\text{[2]}$  pour confirmer le choix et appuyez sur la touche  $\triangle$  /  $\nabla$  pour régler.

### AUDIO INPUT (disponible uniquement en HDMI)

Appuyez sur la touche  $\triangle$  /  $\nabla$  pour sélectionner AUDIO INPUT, puis appuyez sur la touche  $\text{[2]}$  pour confirmer le choix et appuyez sur la touche  $\triangle$  /  $\nabla$  pour choisir DIGITAL ou ANALOG.

OSD VERROUILLAGE

Appuyez longuement sur la touche [  ] pour verrouiller le menu OSD.

OSD DEVERROUILLAGE

Puis appuyez longuement sur la touche [  ] pour déverrouiller le menu OSD.

POWER VERROUILLAGE

Appuyez longuement sur la touche [  ] pour verrouiller l'alimentation.

POWER DEVERROUILLAGE

Puis appuyez longuement sur la touche [  ] pour déverrouiller l'alimentation.

## Installation du moniteur à DEL

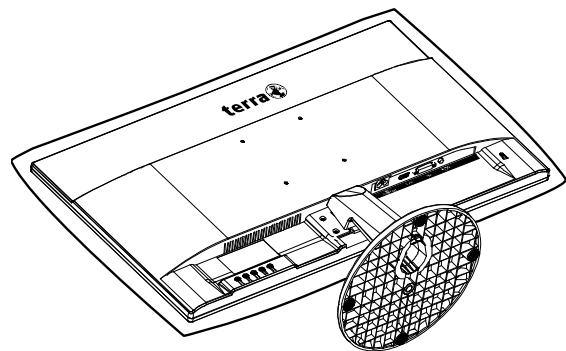
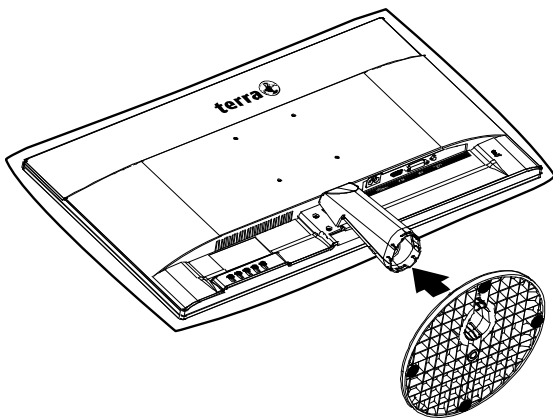

1. Placez le moniteur sur une table, face sur un chiffon doux, ou sur un coussin.
2. Installez la base du support sur le moniteur.

## Modes de fréquence pris en charge

Standard	Résolutions	DVI-D	HDMI
MAC	640x480 @ 67 Hz	✓	✓
VESA	640x480 @ 72 Hz	✓	✓
VESA	640x480@75 Hz	✓	✓
VESA	800x600@56 Hz	✓	✓
VESA	800x600@60 Hz	✓	✓
VESA	800x600@72 Hz	✓	✓
VESA	800x600@75 Hz	✓	✓
VESA	1024x768@60 Hz	✓	✓
VESA	1024x768@70 Hz	✓	✓
VESA	1024x768@75 Hz	✓	✓
VESA	1280x800@60 Hz	✓	✓
VESA	1152x864@75 Hz	✓	✓
VESA	1280x1024@60 Hz	✓	✓
VESA	1280x1024@75 Hz	✓	✓
VESA	1440x900@60 Hz	✓	✓
VESA	1600x1200@60 Hz	✓	✓
VESA	1680x1050@60 Hz	✓	✓
VESA	1920x1080@60 Hz	✓	✓

Mise en garde: Ne configurez pas la carte graphique de votre ordinateur de sorte à dépasser des taux de rafraîchissement maximaux. Vous pourriez causer des dommages permanents à votre moniteur.

## Dépannage

### 1. AUCUNE image à l'écran

- a) Vérifiez si le bouton Marche/Arrêt est allumé.
- b) Vérifiez que la luminosité et le contraste du moniteur est dans les limites du réglage normal.
- c) Vérifiez si le voyant d'alimentation clignote. Si c'est le cas, ceci indique que le moniteur ne reçoit pas de signal d'entrée.
- d) Si l'indicateur de signal est un bloc-notes ou un ordinateur portable, vérifiez que le signal est passé au mode écran.

### 2. Image floue

- a) Vérifiez si le câble de signal d'image est inséré comme il faut (position verticale).

### 3. L'écran clignote

- a) Le courant est insuffisant pour connecter le moniteur ou bien trop faible.
- b) Pour éviter la présence de champ magnétique autour du moniteur, ne placez pas trop près des appareils tels que les haut-parleurs, les éclairages fluorescents, les transformateurs CA, les ventilateurs de table, etc.

### 4. Couleur erroné e ou inhabituelle

- a) Si le rouge, le vert, le bleu ou l'une des couleurs disparaît, vérifiez que le cordon de signal est branché correctement. Si la prise est branchée de manière relâchée, ceci pourrait causer une mauvaise connexion.
- b) Essayez de connecter à un autre PC pour comparer.

### 5. Comment nettoyer le moniteur

- a) Vérifiez que le moniteur est éteint.
- b) Ne vaporisez pas du liquide directement sur l'écran ou sur le panneau en plastique.

### 6. Lors du nettoyage de l'écran

- a) Utilisez un tissu propre, doux et non pelucheux pour nettoyer l'écran.
- b) En cas de saletés tenaces, ajoutez un peu de liquide non-ammoniacal et de nettoyant à vitres sans alcool pour nettoyer l'écran.

### 7. Lors du nettoyage du panneau en plastique

- a) Utilisez un chiffon sec et doux.
- b) Ajoutez un peu de liquide non-ammoniacal et de nettoyant non-abrasif sans teneur en alcool pour nettoyer la surface si c'est toujours sale.

**SPÉCIFICATIONS:**

Dimension	27"	
Type de moniteur	DEL	
Luminosité	300 cd/m <sup>2</sup>	
Couleur	16.7M	
Résolutions	1920x1080@60 Hz	
Alimentation requise	100-240V ~ 60/50 Hz	
Consommation électrique	<22 W	
Connecteur d'entrée	DVI-D	Connecteur DVI-D 24+1 broches
	HDMI	Connecteur HDMI Ver1.4
	Entrée audio	Prise stéréo 3,5 mm
Environnement	Temp. de fonctionnement: 0°C~40°C Humidité: Moins de 80% Température de stockage: -20°C~60°C	

## WEEE Statement



### Wichtige Recyclinginformation

Das Gerät darf nach dem Ende der Nutzungszeit nicht mit dem Restmüll entsorgt werden. Bitte führen Sie es zur umweltgerechten Entsorgung den kommunalen Altgeräte-Sammelstellen zu.

Für weitere Informationen wenden Sie sich bitte an die unten stehende Adresse.

### Important Information for Recycling

This warning sign of trash bin indicates that the objects are not allowed to be disposed as general refuse. Please follow the local act and carry out further disposal with refuse recycling and collecting system in your Country or District.

Please contact the address below for more information on recycling.

### Informations importantes relatives au recyclage

En fin de vie, cet appareil ne doit pas être jeté aux ordures ménagères.

Veillez respecter les réglementations locales et rester en conformité avec le système de collecte et de recyclage des ordures en vigueur dans votre région.

Pour plus d'information sur le recyclage, veuillez contacter votre centre de recyclage agréé.

Votre attitude quand au recyclage améliorera l'avenir de la planète et créera un environnement de vie de qualité pour les générations futures.

### Wortmann AG

Bredenhop 20

D-32609 Hüllhorst

Tel. +49 (0) 5744 /944-0

Fax +49 (0) 5744 / 944-444

[www.wortmann.de](http://www.wortmann.de)

[info@wortmann.de](mailto:info@wortmann.de)

# GENERAL PUBLIC LICENSE (GPL) - VER.2

## Lizenzinformation Open Source Software/GPL Sourcecode

Dieses Produkt enthält Software, die von Dritten stammt, darunter auch Software, die unter der GNU General Public License Version 2 ("GPLv2") und der GNU Lesser General Public License, Version 1.2 (LGPLv2.1) lizenziert ist. Solche Programmbestandteile werden nachfolgend als „Programm“ oder „Program“ bezeichnet.

## Schriftliches Angebot des GPL/LGPL Sourcecodes

Wir werden gegen Erstattung der Kosten für den Datenträger und den Versand des Datenträgers auf Nachfrage jedermann den Sourcecode der GPL- und LGPL-Bestandteile der Software auf einer CD-ROM oder einem ähnlichen Datenträger übersenden. Dieses Angebot ist gültig für einen Zeitraum von drei Jahren ab Erwerb des Produktes.

Bei Nachfragen im Zusammenhang mit GPLv2 und LGPLv2.1: Bitte richten Sie alle GPL/LGPL-Nachfragen an die nachfolgend angegebene Adresse. Wir weisen darauf hin, dass unter der angegebenen Adresse kein technischer Support geleistet wird.

## LICENSE STATEMENT / GPL CODE STATEMENT

This product includes software code developed by third parties, including software code subject to the GNU General Public License Version 2 ("GPLv2") and the GNU Lesser General Public License, Version 1.2 (LGPLv2.1). These parts of the software are hereinafter referred to as „the or this Program“

## WRITTEN OFFER FOR GPL/LGPL SOURCE CODE

We will provide everyone upon request the applicable GPL and LGPL source code files via CD-ROM or similar storage medium for a nominal cost to cover shipping and media charges as allowed under the GPL/LGPL. This offer is valid for 3 years.

GPLv2 and LGPLv2.1 inquiries: Please direct all GPL/LGPL inquiries to the following address. Note that technical support inquiries will not be supported at the below address.

WORTMANN AG  
- GPL ANFRAGE -  
Bredenhop 20  
32609 Hüllhorst  
Deutschland

## NO WARRANTY

This program is distributed in the hope that it will be useful, but WITHOUT ANY WARRANTY; without even the implied warranty of MERCHANTABILITY or FITNESS FOR A PARTICULAR PURPOSE. See the GNU General Public License for more details.

IN NO EVENT UNLESS REQUIRED BY APPLICABLE LAW OR AGREED TO IN WRITING WILL ANY COPYRIGHT HOLDER, OR ANY OTHER PARTY WHO MAY MODIFY AND/OR REDISTRIBUTE THE PROGRAM AS PERMITTED ABOVE, BE LIABLE TO YOU FOR DAMAGES, INCLUDING ANY GENERAL, SPECIAL, INCIDENTAL OR CONSEQUENTIAL DAMAGES ARISING OUT OF THE USE OR INABILITY TO USE THE PROGRAM (INCLUDING BUT NOT LIMITED TO LOSS OF DATA OR DATA BEING RENDERED INACCURATE OR LOSSES SUSTAINED BY YOU OR THIRD PARTIES OR A FAILURE OF THE PROGRAM TO OPERATE WITH ANY OTHER PROGRAMS), EVEN IF SUCH HOLDER OR OTHER PARTY HAS BEEN ADVISED OF THE POSSIBILITY OF SUCH DAMAGES.

## GNU GENERAL PUBLIC LICENSE

Version 2, June 1991

Copyright (C) 1989, 1991 Free Software Foundation, Inc. 51 Franklin Street, Fifth Floor, Boston, MA 02110-1301, USA

Everyone is permitted to copy and distribute verbatim copies of this license document, but changing it is not allowed.

### Preamble

The licenses for most software are designed to take away your freedom to share and change it. By contrast, the GNU General Public License is intended to guarantee your freedom to share and change free software--to make sure the software is free for all its users. This General Public License applies to most of the Free Software Foundation's software and to any other program whose authors commit to using it. (Some other Free Software Foundation software is covered by the GNU Lesser General Public License instead.) You can apply it to your programs, too. When we speak of free software, we are referring to freedom, not price. Our General Public Licenses are designed to make sure that you have the freedom to distribute copies of free software (and charge for this service if you wish), that you receive source code or can get it if you want it, that you can change the software or use pieces of it in new free programs; and that you know you can do these things. To protect your rights, we need to make restrictions that forbid anyone to deny you these rights or to ask you to surrender the rights. These restrictions translate to certain responsibilities for you if you distribute copies of the software, or if you modify it. For example, if you distribute copies of such a program, whether gratis or for a fee, you must give the recipients all the rights that you have. You must make sure that they, too, receive or can get the source code. And you must show them these terms so they know their rights.

We protect your rights with two steps: (1) copyright the software, and (2) offer you this license which gives you legal permission to copy, distribute and/or modify the software. Also, for each author's protection and ours, we want to make certain that everyone understands that there is no warranty for this free software. If the software is modified by someone else and passed on, we want its recipients to know that what they have is not the original, so that any problems introduced by others will not reflect on the original authors' reputations. Finally, any free program is threatened constantly by software patents. We wish to avoid the danger that redistributors of a free program will individually obtain patent licenses, in effect making the program proprietary. To prevent this, we have made it clear that any patent must be licensed for everyone's free use or not licensed at all. The precise terms and conditions for copying, distribution and modification follow.

### TERMS AND CONDITIONS FOR COPYING, DISTRIBUTION AND MODIFICATION

0. This License applies to any program or other work which contains a notice placed by the copyright holder saying it may be distributed under the terms of this General Public License. The „Program“, below, refers to any such program or work, and a „work based on the Program“ means either the Program or any derivative work under copyright law: that is to say, a work containing the Program or a portion of it, either verbatim or with modifications and/or translated into another language. (Hereinafter, translation is included without limitation in the term „modification“.) Each licensee is addressed as „you“. Activities other than copying, distribution and modification are not covered by this License; they are outside its scope. The act of running the Program is not restricted, and the output from the Program is covered only if its contents constitute a work based on the Program (independent of having been made by running the Program). Whether that is true depends on what the Program does.

1. You may copy and distribute verbatim copies of the Program's source code as you receive it, in any medium, provided that you conspicuously and appropriately publish on each copy an appropriate copyright notice and disclaimer of warranty; keep intact all the notices that refer to this License and to the absence of any warranty; and give any other recipients of the Program a copy of this License along with the Program.

You may charge a fee for the physical act of transferring a copy, and you may at your option offer warranty protection in exchange for a fee.

2. You may modify your copy or copies of the Program or any portion of it, thus forming a work based on the Program, and copy and distribute such modifications or work under the terms of Section 1 above, provided that you also meet all of these conditions:

- a) You must cause the modified files to carry prominent notices stating that you changed the files and the date of any change.
- b) You must cause any work that you distribute or publish, that in whole or in part contains or is derived from the Program or any part thereof, to be licensed as a whole at no charge to all third parties under the terms of this License.
- c) If the modified program normally reads commands interactively when run, you must cause it, when started running for such interactive use in the most ordinary way, to print or display an announcement including an appropriate copyright notice and a notice that there is no warranty (or else, saying that you provide a warranty) and that users may redistribute the program under these conditions, and telling the user how to view a copy of this License. (Exception: if the Program itself is interactive but does not normally print such an announcement, your work based on the Program is not required to print an announcement.) These requirements apply to the modified work as a whole. If identifiable sections of that work are not derived from the Program, and can be reasonably considered independent and separate works in themselves, then this License, and its terms, do not apply to those sections when you distribute them as separate works. But when you distribute the same sections as part of a whole which is a work based on the Program, the distribution of the whole must be on the terms of this License, whose permissions for other licensees extend to the entire whole, and thus to each and every part regardless of who wrote it. Thus, it is not the intent of this section to claim rights or contest your rights to work written entirely by you; rather, the intent is to exercise the right to control the distribution of derivative or collective works based on the Program. In addition, mere aggregation of another work not based on the Program with the Program (or

with a work based on the Program) on a volume of a storage or distribution medium does not bring the other work under the scope of this License.

3. You may copy and distribute the Program (or a work based on it, under Section 2) in object code or executable form under the terms of Sections 1 and 2 above provided that you also do one of the following:

we use this doubled UL to get the sub-sections indented, while making the bullets as unobvious as possible.

a) Accompany it with the complete corresponding machinereadable source code, which must be distributed under the terms of Sections 1 and 2 above on a medium customarily used for software interchange; or,

b) Accompany it with a written offer, valid for at least three years, to give any third party, for a charge no more than your cost of physically performing source distribution, a complete machine-readable copy of the corresponding source code, to be distributed under the terms of Sections 1 and 2 above on a medium customarily used for software interchange; or,

c) Accompany it with the information you received as to the offer to distribute corresponding source code. [This alternative is allowed only for noncommercial distribution and only if you received the program in object code or executable form with such an offer, in accord with Subsection b above.] The source code for a work means the preferred form of the work for making modifications to it. For an executable work, complete source code means all the source code for all modules it contains, plus any associated interface definition files, plus the scripts used to control compilation and installation of the executable. However, as a special exception, the source code distributed need not include anything that is normally distributed (in either source or binary form) with the major components (compiler, kernel, and so on) of the operating system on which the executable runs, unless that component itself accompanies the executable. If distribution of executable or object code is made by offering access to copy from a designated place, then offering equivalent access to copy the source code from the same place counts as distribution of the source code, even though third parties are not compelled to copy the source along with the object code.

4. You may not copy, modify, sublicense, or distribute the Program except as expressly provided under this License. Any attempt otherwise to copy, modify, sublicense or distribute the Program is void, and will automatically terminate your rights under this License. However, parties who have received copies, or rights, from you under this License will not have their licenses terminated so long as such parties remain in full compliance.

5. You are not required to accept this License, since you have not signed it. However, nothing else grants you permission to modify or distribute the Program or its derivative works. These actions are prohibited by law if you do not accept this License. Therefore, by modifying or distributing the Program (or any work based on the Program), you indicate your acceptance of this License to do so, and all its terms and conditions for copying, distributing or modifying the Program or works based on it.

6. Each time you redistribute the Program (or any work based on the Program), the recipient automatically receives a license from the original licensor to copy, distribute or modify the Program subject to these terms and conditions. You may not impose any further restrictions on the recipients' exercise of the rights granted herein. You are not responsible for enforcing compliance by third parties to this License.

7. If, as a consequence of a court judgment or allegation of patent infringement or for any other reason (not limited to patent issues), conditions are imposed on you (whether by court order, agreement or otherwise) that contradict the conditions of this License, they do not excuse you from the conditions of this License. If you cannot distribute so as to satisfy simultaneously your obligations under this License and any other pertinent obligations, then as a consequence you may not distribute the Program at all. For example, if a patent license would not permit royalty-free redistribution of the Program by all those who receive copies directly or indirectly through you, then the only way you could satisfy both it and this License would be to refrain entirely from distribution of the Program.

If any portion of this section is held invalid or unenforceable under any particular circumstance, the balance of the section is intended to apply and the section as a whole is intended to apply in other circumstances.

It is not the purpose of this section to induce you to infringe any patents or other property right claims or to contest validity of any such claims; this section has the sole purpose of protecting the integrity of the free software distribution system, which is implemented by public license practices. Many people have made generous contributions to the wide range of software distributed through that system in reliance on consistent application of that system; it is up to the author/donor to decide if he or she is willing to distribute software through any other system and a licensee cannot impose that choice. This section is intended to make thoroughly clear what is believed to be a consequence of the rest of this License.

8. If the distribution and/or use of the Program is restricted in certain countries either by patents or by copyrighted interfaces, the original copyright holder who places the Program under this License may add an explicit geographical distribution limitation excluding those countries, so that distribution is permitted only in or among countries not thus excluded. In such case, this License incorporates the limitation as if written in the body of this License.

9. The Free Software Foundation may publish revised and/or new versions of the General Public License from time to time. Such new versions will be similar in spirit to the present version, but may differ in detail to address new problems or concerns.

Each version is given a distinguishing version number. If the Program specifies a version number of this License which applies to it and „any later version“, you have the option of following the terms and conditions either of that version or of any later version published by the Free Software Foundation. If the Program does not specify a version number of this License, you may choose any version ever published by the Free Software Foundation.

10. If you wish to incorporate parts of the Program into other free programs whose distribution conditions are different, write to the author to ask for permission. For software which is copyrighted by the Free Software Foundation, write to the Free Software Foundation; we sometimes make exceptions for this. Our decision will be guided by the two goals of preserving the free status of all derivatives of our free software and of promoting the sharing and reuse of software generally.

#### NO WARRANTY

11. BECAUSE THE PROGRAM IS LICENSED FREE OF CHARGE, THERE IS NO WARRANTY FOR THE PROGRAM, TO THE EXTENT PERMITTED BY APPLICABLE LAW. EXCEPT WHEN OTHERWISE STATED IN WRITING THE COPYRIGHT HOLDERS AND/OR OTHER PARTIES PROVIDE THE PROGRAM „AS IS“ WITHOUT WARRANTY OF ANY KIND, EITHER EXPRESSED OR IMPLIED, INCLUDING, BUT NOT LIMITED TO, THE IMPLIED WARRANTIES OF MERCHANTABILITY AND FITNESS FOR A PARTICULAR PURPOSE. THE ENTIRE RISK AS TO THE QUALITY AND PERFORMANCE OF THE PROGRAM IS WITH YOU. SHOULD THE PROGRAM PROVE DEFECTIVE, YOU ASSUME THE COST OF ALL NECESSARY SERVICING, REPAIR OR CORRECTION.

12. IN NO EVENT UNLESS REQUIRED BY APPLICABLE LAW OR AGREED TO IN WRITING WILL ANY COPYRIGHT HOLDER, OR ANY OTHER PARTY WHO MAY MODIFY AND/OR REDISTRIBUTE THE PROGRAM AS PERMITTED ABOVE, BE LIABLE TO YOU FOR DAMAGES, INCLUDING ANY GENERAL, SPECIAL, INCIDENTAL OR CONSEQUENTIAL DAMAGES ARISING OUT OF THE USE OR INABILITY TO USE THE PROGRAM (INCLUDING BUT NOT LIMITED TO LOSS OF DATA OR DATA BEING RENDERED INACCURATE OR LOSSES SUSTAINED BY YOU OR THIRD PARTIES OR A FAILURE OF THE PROGRAM TO OPERATE WITH ANY OTHER PROGRAMS), EVEN IF SUCH HOLDER OR OTHER PARTY HAS BEEN ADVISED OF THE POSSIBILITY OF SUCH DAMAGES.

#### END OF TERMS AND CONDITIONS

##### How to Apply These Terms to Your New Programs

If you develop a new program, and you want it to be of the greatest possible use to the public, the best way to achieve this is to make it free software which everyone can redistribute and change under these terms.

To do so, attach the following notices to the program. It is safest to attach them to the start of each source file to most effectively state the exclusion of warranty; and each file should have at least the "copyright" line and a pointer to where the full notice is found.

```
<one line to give the program's name and a brief idea of what it does.>
Copyright (C) <year> <name of author>
```

This program is free software: you can redistribute it and/or modify it under the terms of the GNU General Public License as published by the Free Software Foundation, either version 3 of the License, or (at your option) any later version.

This program is distributed in the hope that it will be useful, but WITHOUT ANY WARRANTY; without even the implied warranty of MERCHANTABILITY or FITNESS FOR A PARTICULAR PURPOSE. See the GNU General Public License for more details.

You should have received a copy of the GNU General Public License along with this program. If not, see <http://www.gnu.org/licenses/>.

Also add information on how to contact you by electronic and paper mail.

If the program does terminal interaction, make it output a short notice like this when it starts in an interactive mode:

```
<program> Copyright (C) <year> <name of author>
This program comes with ABSOLUTELY NO WARRANTY; for details type `show w`.
This is free software, and you are welcome to redistribute it under certain conditions;
type `show c` for details.
```

The hypothetical commands `show w` and `show c` should show the appropriate parts of the General Public License. Of course, your program's commands might be different; for a GUI interface, you would use an "about box".

You should also get your employer (if you work as a programmer) or school, if any, to sign a "copyright disclaimer" for the program, if necessary. For more information on this, and how to apply and follow the GNU GPL, see <http://www.gnu.org/licenses/>.

The GNU General Public License does not permit incorporating your program into proprietary programs. If your program is a subroutine library, you may consider it more useful to permit linking proprietary applications with the library. If this is what you want to do, use the GNU Lesser General Public License instead of this License. But first, please read <http://www.gnu.org/philosophy/why-not-lgpl.html>.

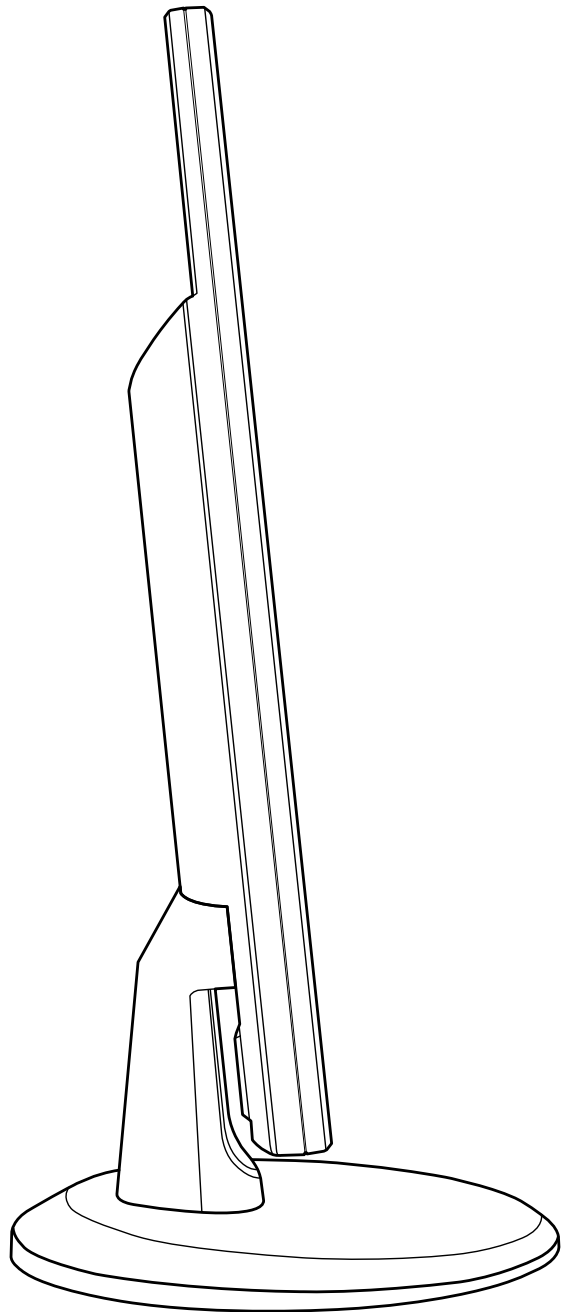
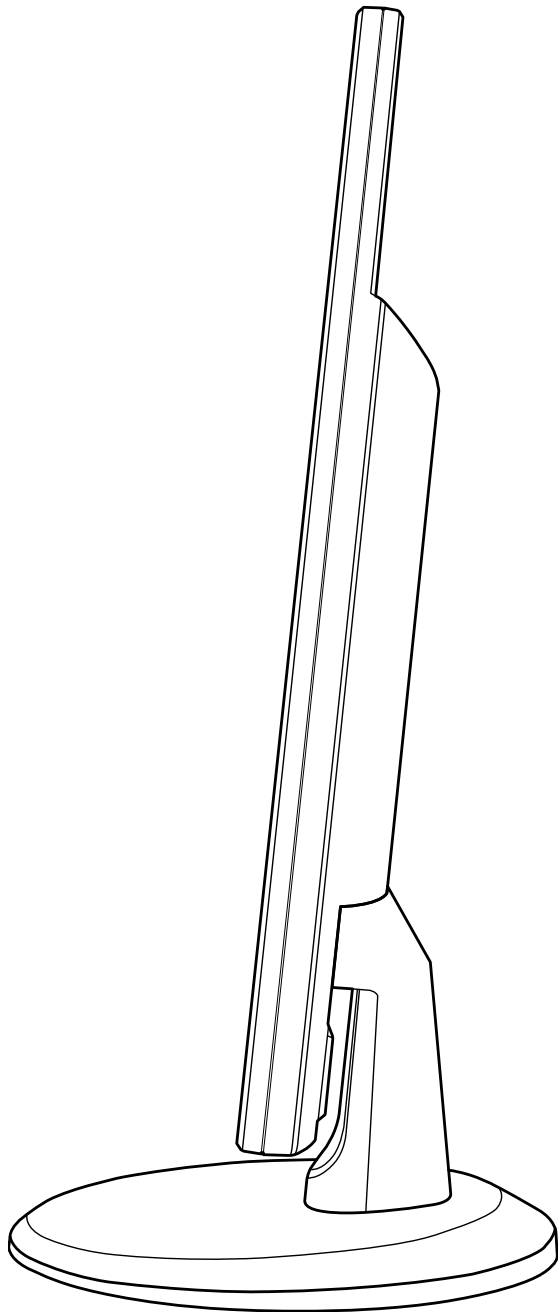

Bredenhop 20\_32609 Hüllhorst  
Tel +49 5744.944-0\_Fax +49 5744.944-100  
[www.wortmann.de](http://www.wortmann.de)